

4x2

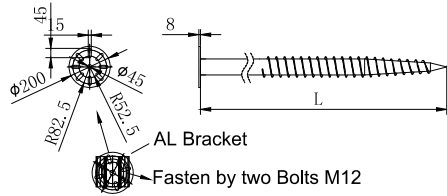

AL Bracket
Fasten by two Bolts M12

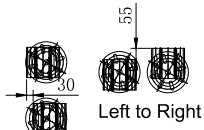

Front to Back
Adjust

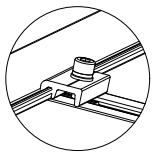
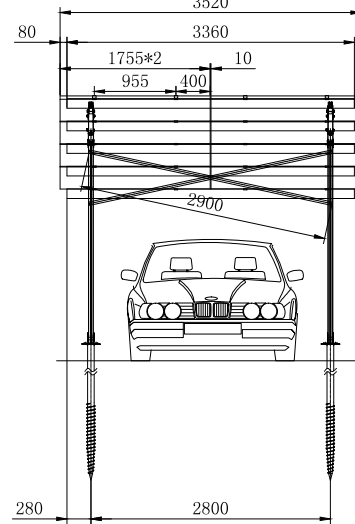
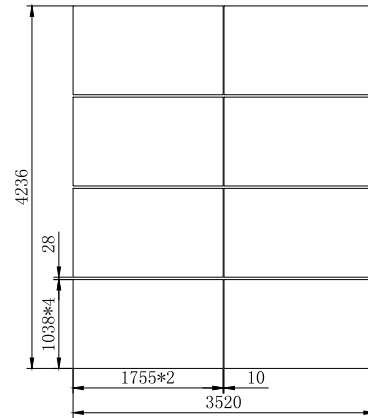
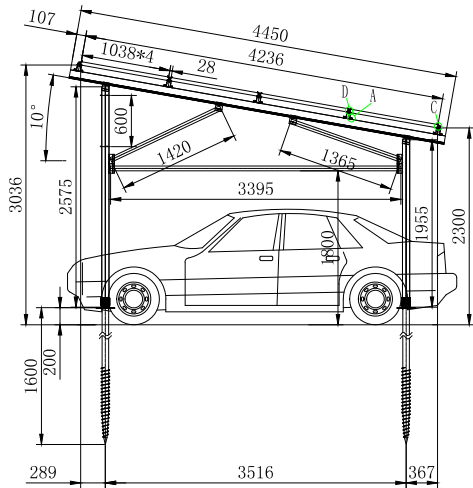
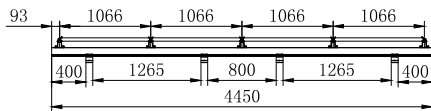

A

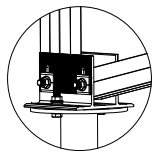

B

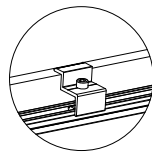

C

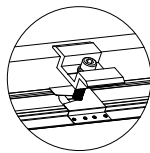

D

*** Technical information ***

1. Module Size 1755x1038x30mm;
2. Basic Wind Load is 55m/s, Snow Load is 50cm(JIS C8955-2017);
3. Ground Screw capacity must be test according to the ground condition of install site.