

TUTO

Installation et paramétrage Marstek Venus E + CT002





VERS RESEAU ENEDIS

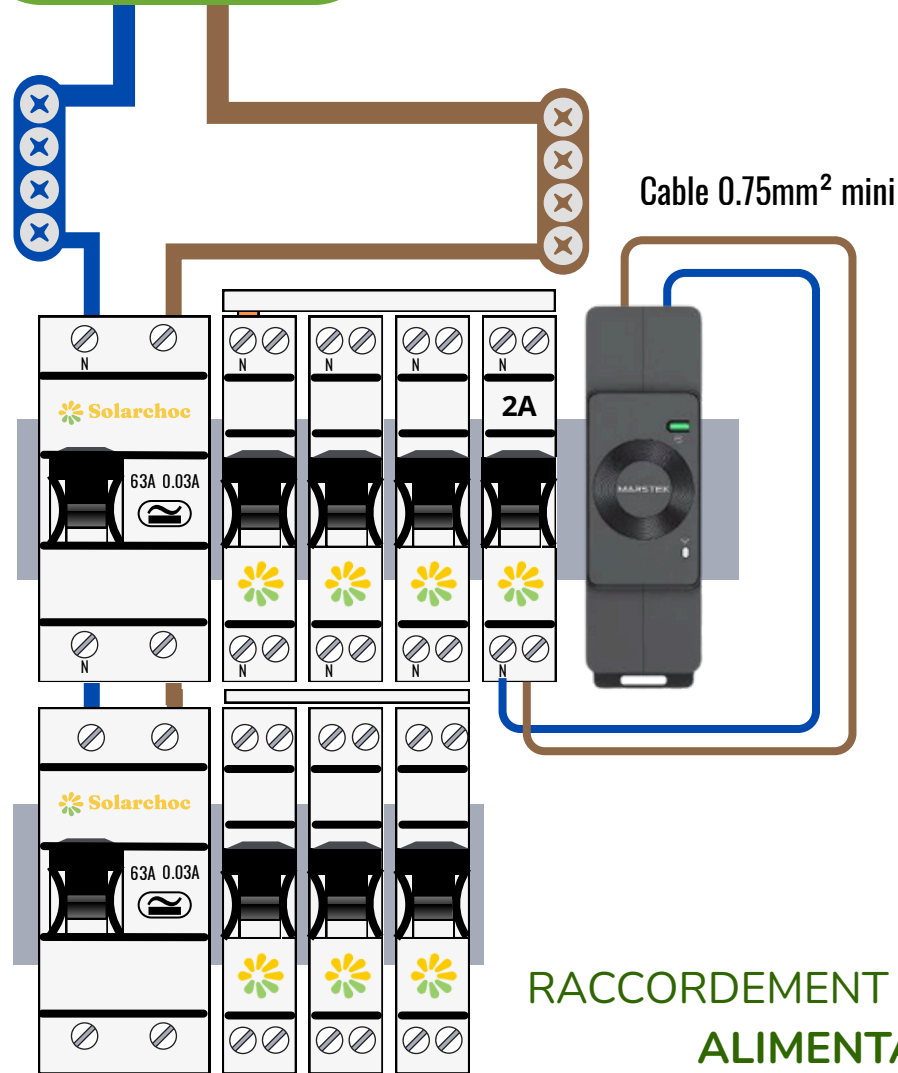

RACCORDEMENT DU COMPTEUR AU TABLEAU :
ALIMENTATION MONOPHASÉE

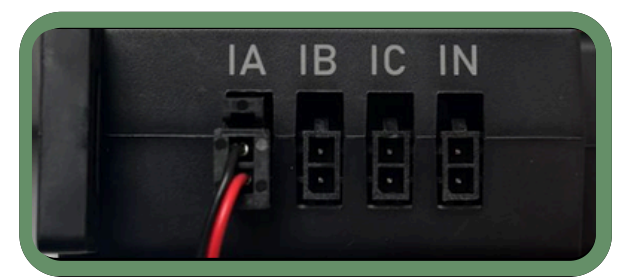
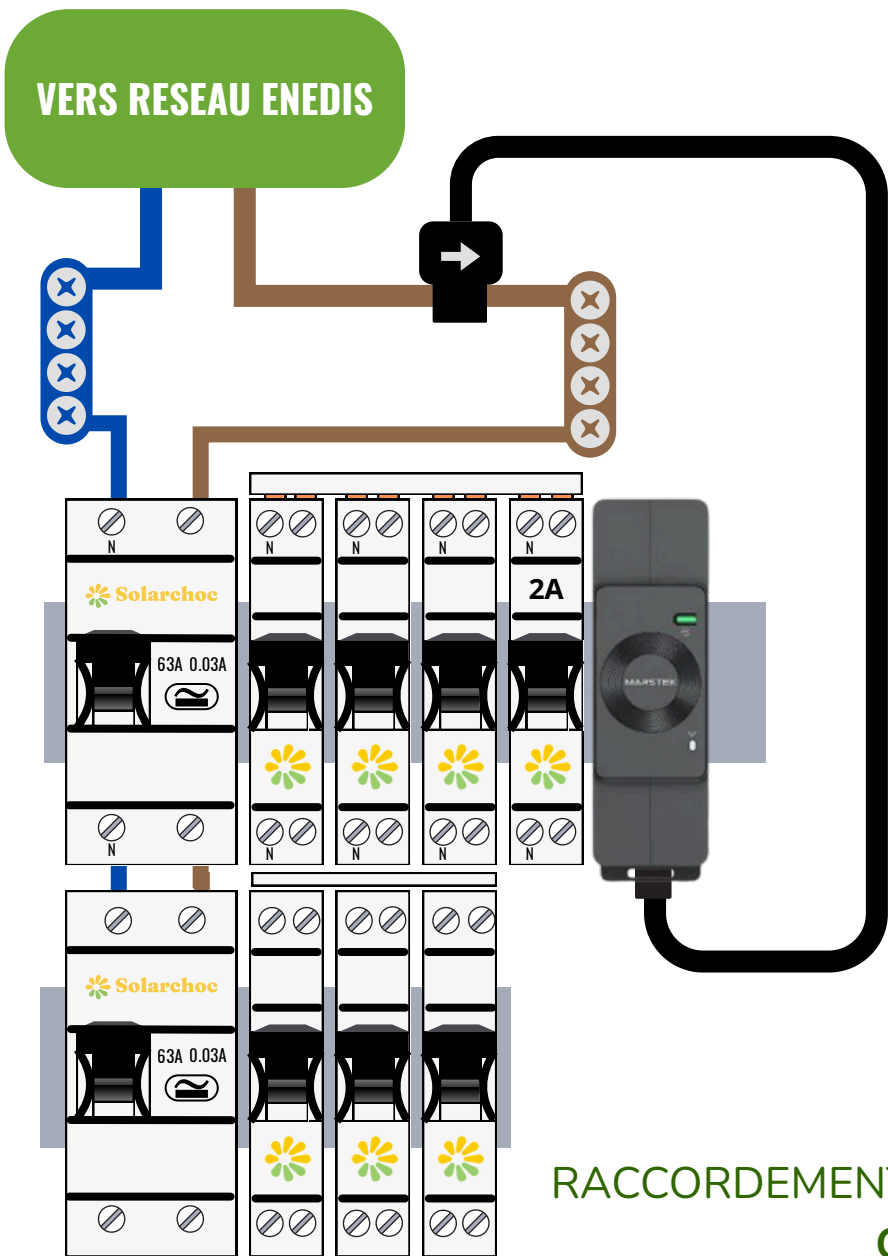

RACCORDEMENT DU COMPTEUR AU TABLEAU :
CT MONOPHASE

2. Configuration

Vous devez avoir accès à un compte Marstek pour Configurer la batterie et le compteur.



Si vous n'avez pas encore d'accès à l'application, merci de créer votre compte..

Après la création de l'app, bien autoriser tous les accès (Localisation, Bluetooth, etc..)

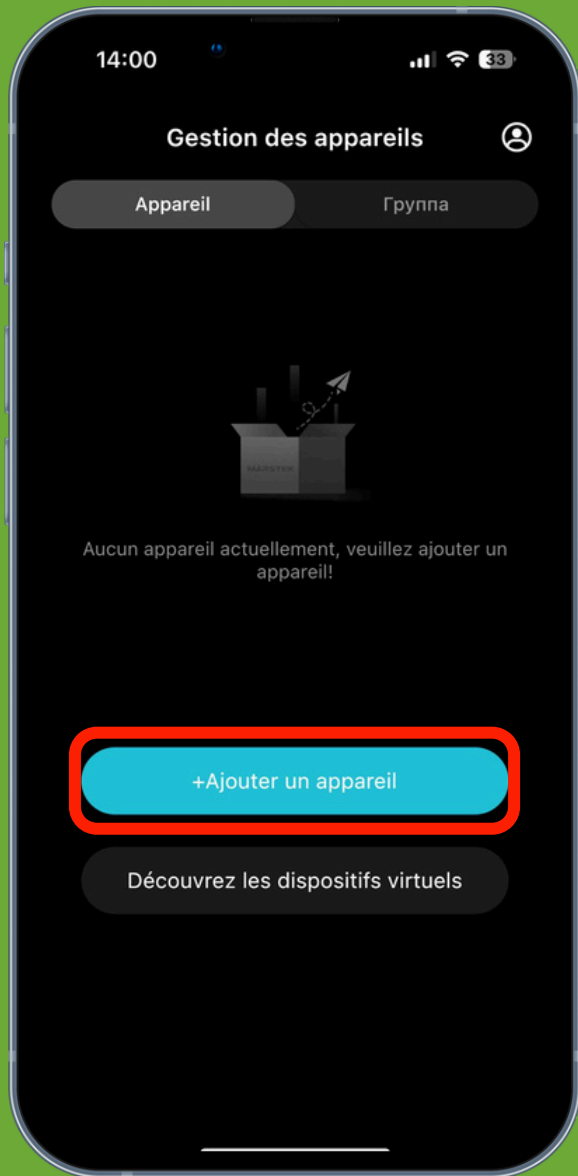

Commencer la configuration d'un nouvel appareil

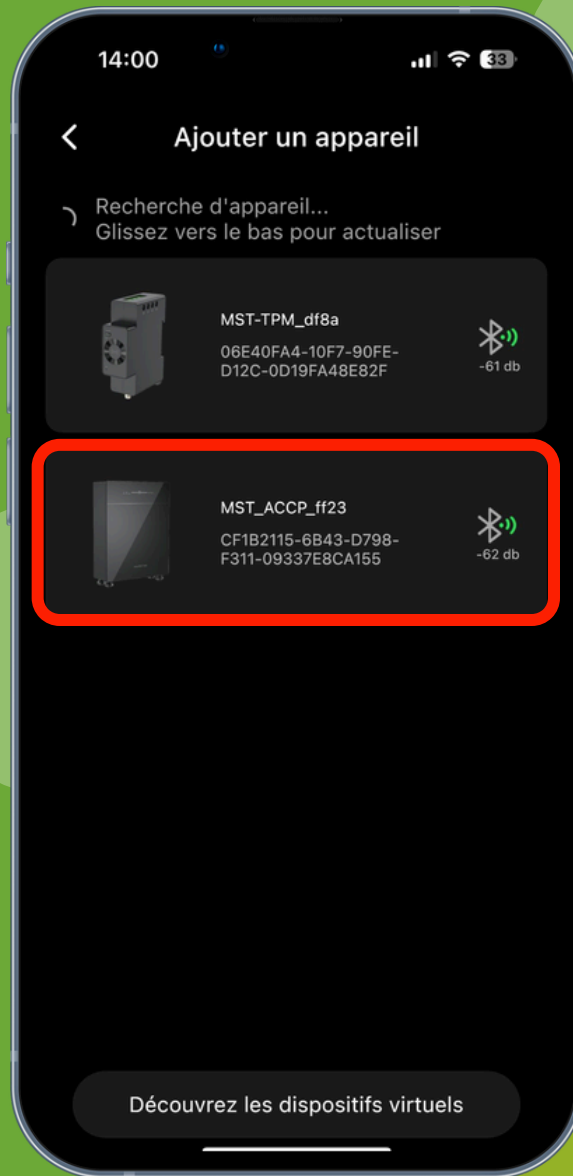

Sélectionner la méthode d'appairage par Bluetooth. Nécessite le Bluetooth sur le téléphone

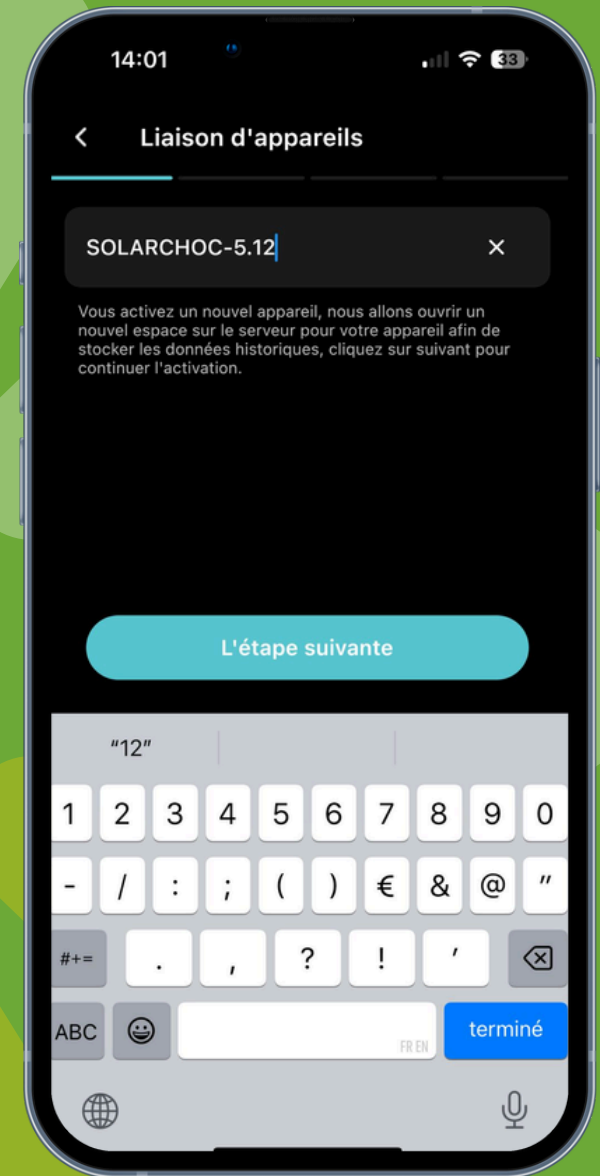

Nommer la batterie

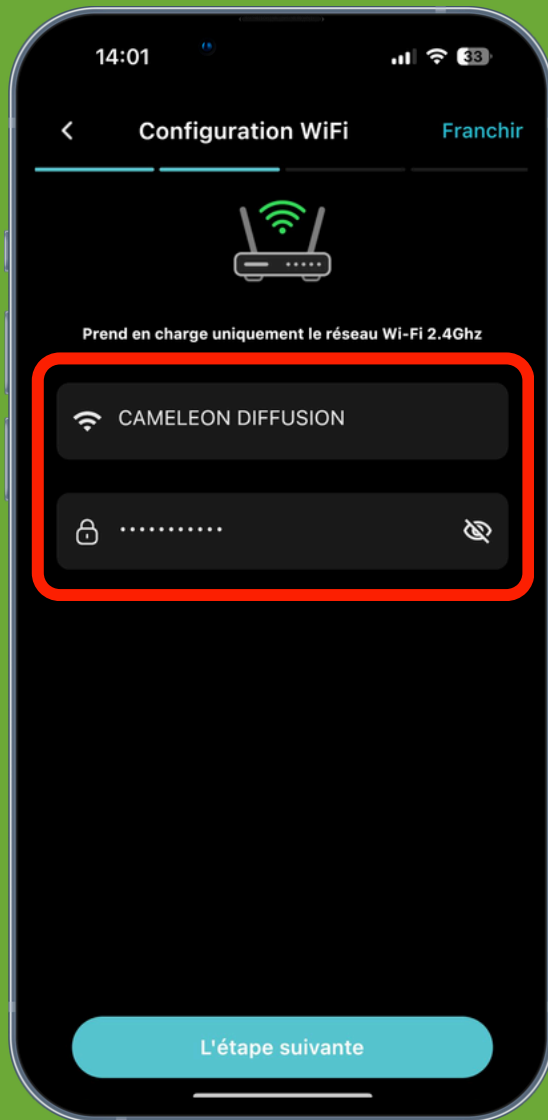

Configurer le réseau Wifi

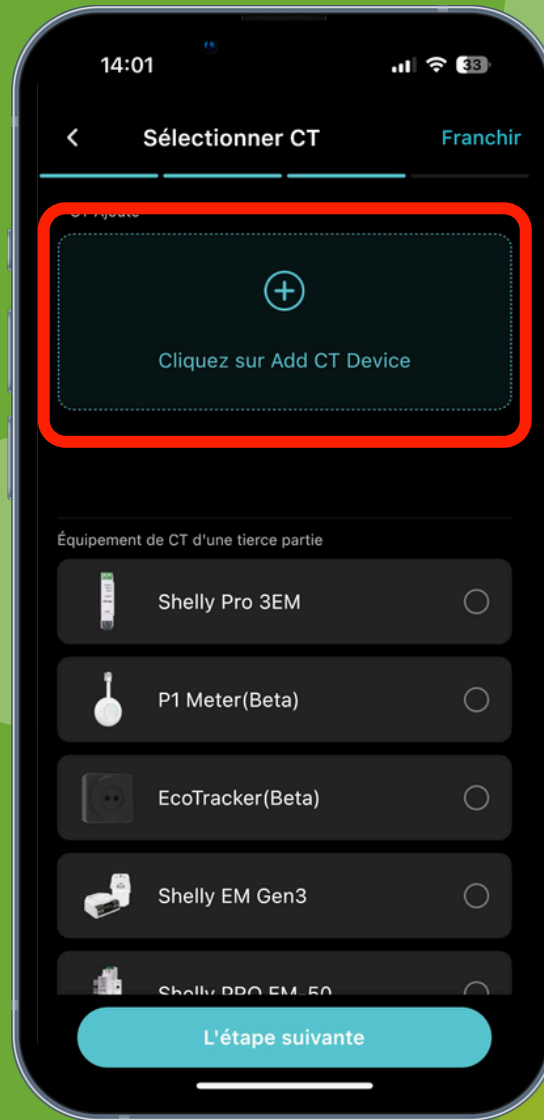

Sélectionner le CT

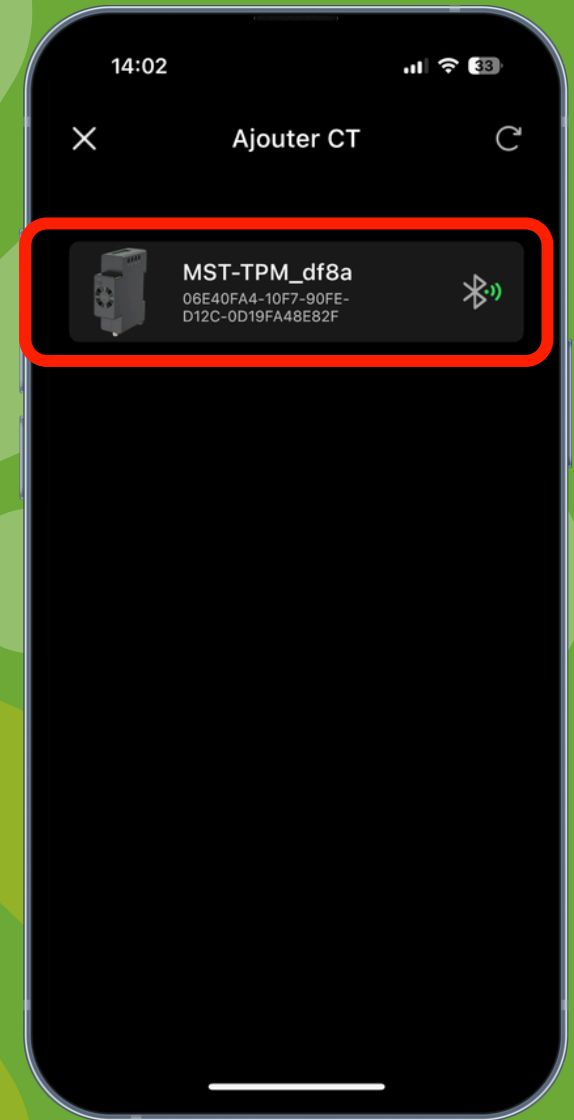

Cliquer sur le CT002

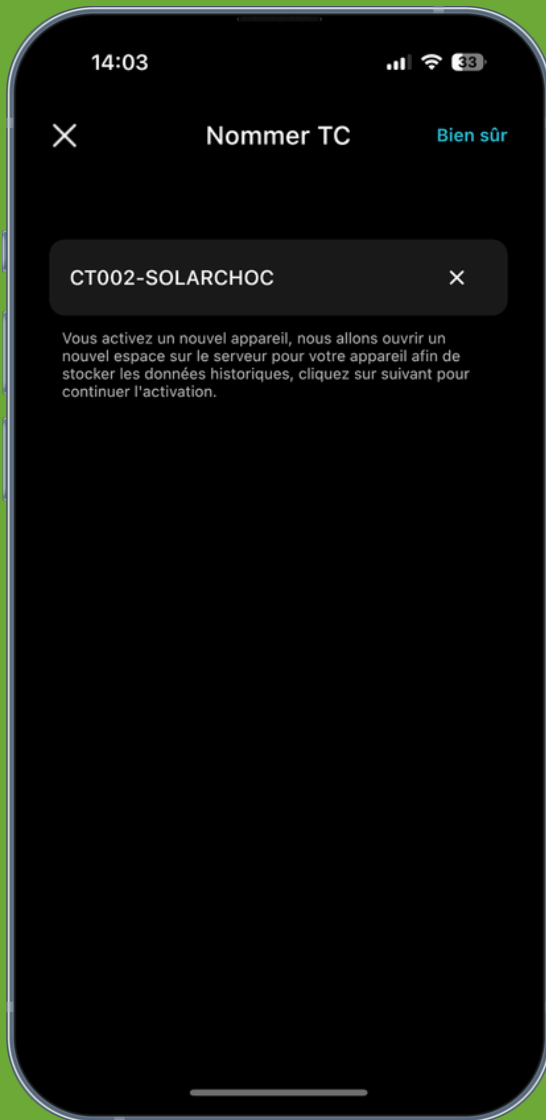

Nommer le CT

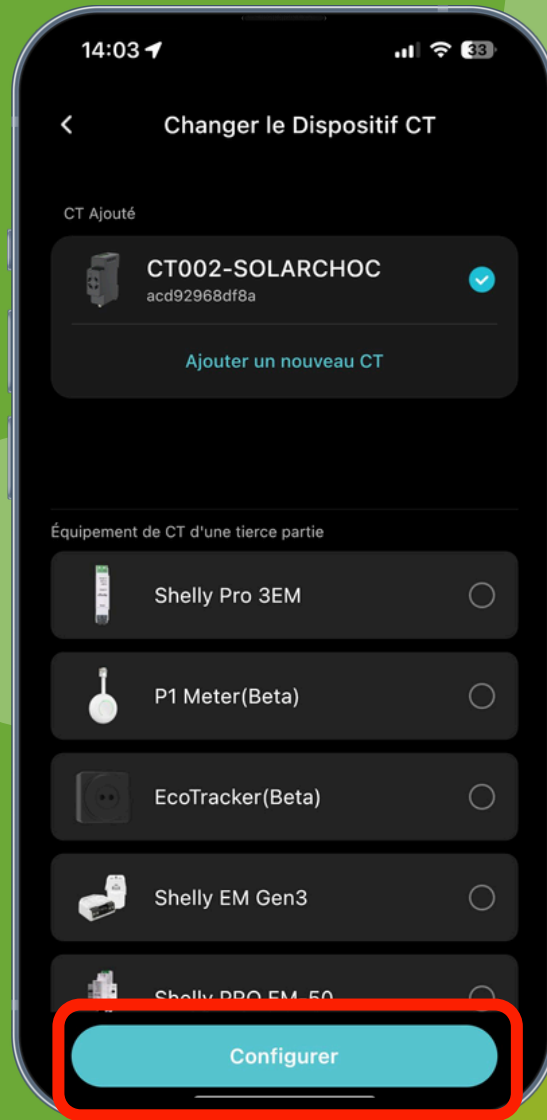

Le sélectionner et appuyer sur configurer



Puis sur "OK"



Sélectionner le CT

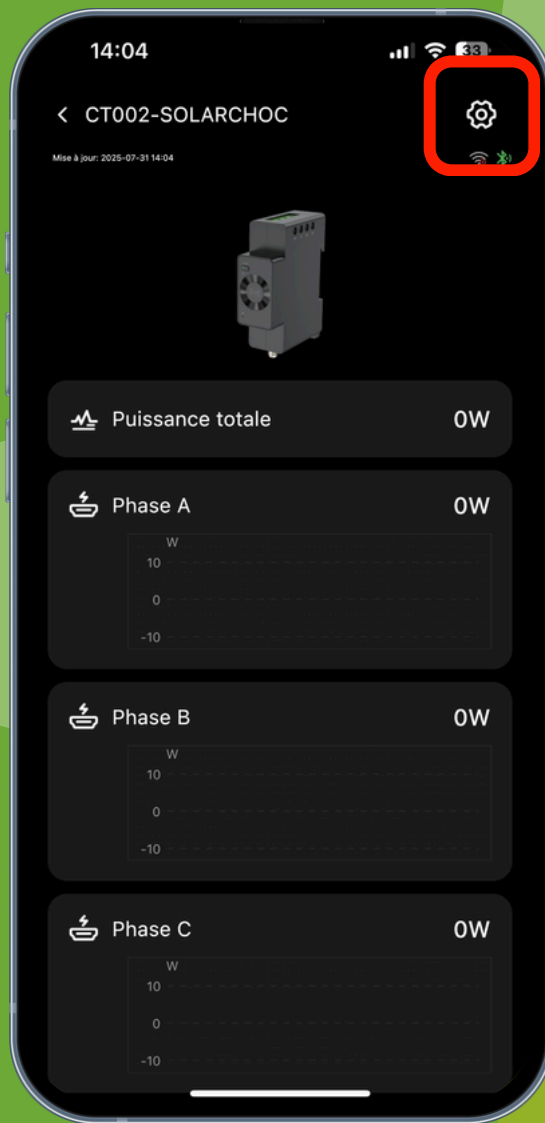

Aller dans paramètres

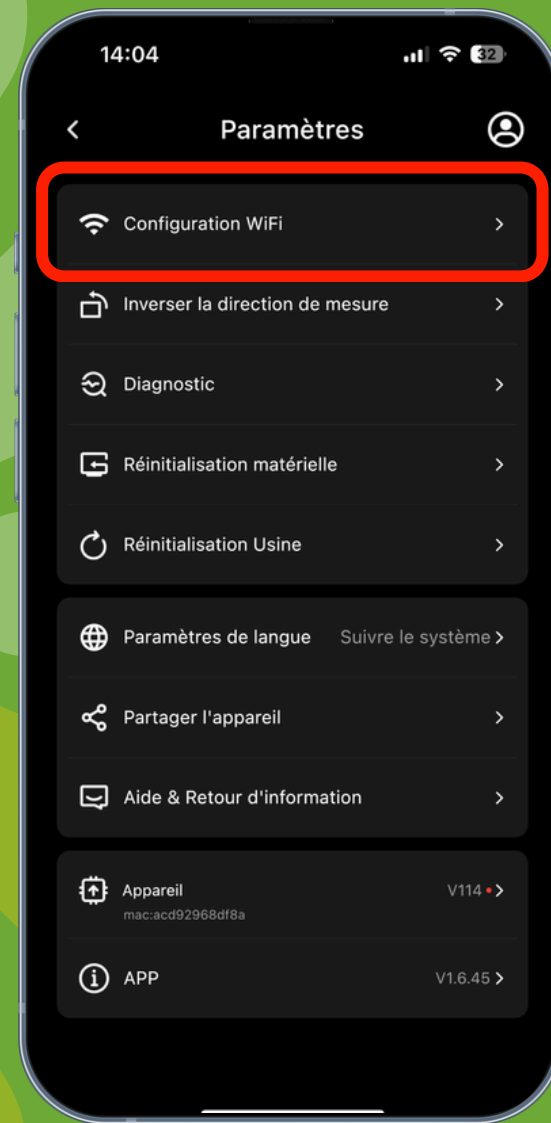

Et configuration Wifi

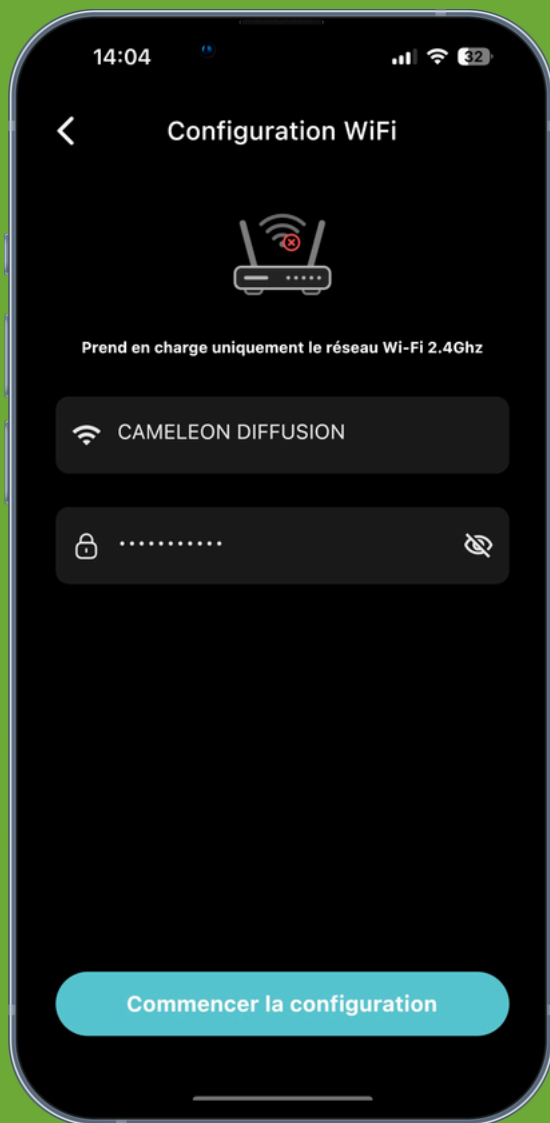

Configurer le réseau Wifi
du CT

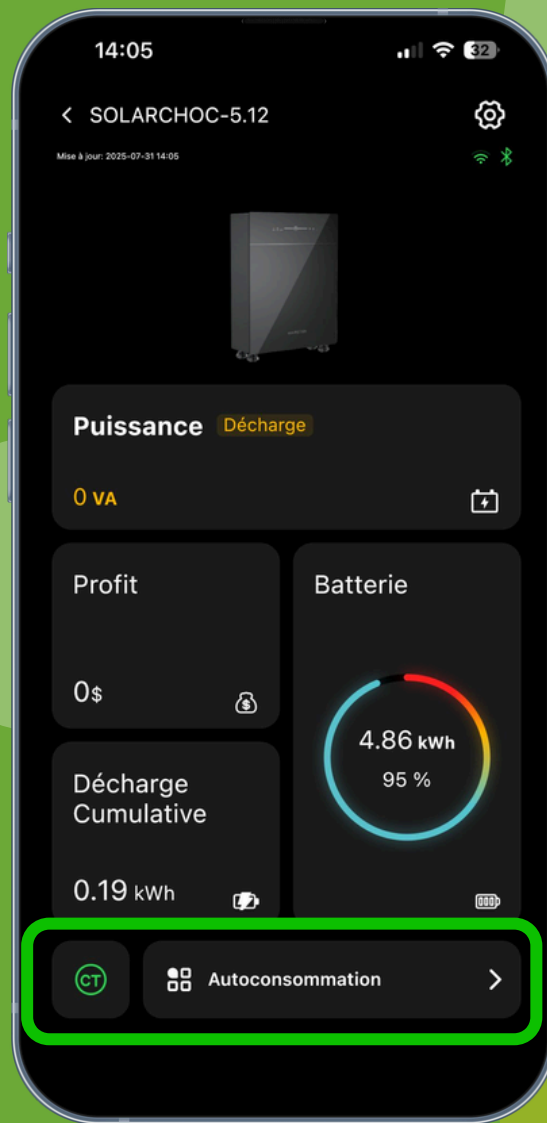

Vérifier la bonne connexion des éléments
(tous les sigles en vert)

